

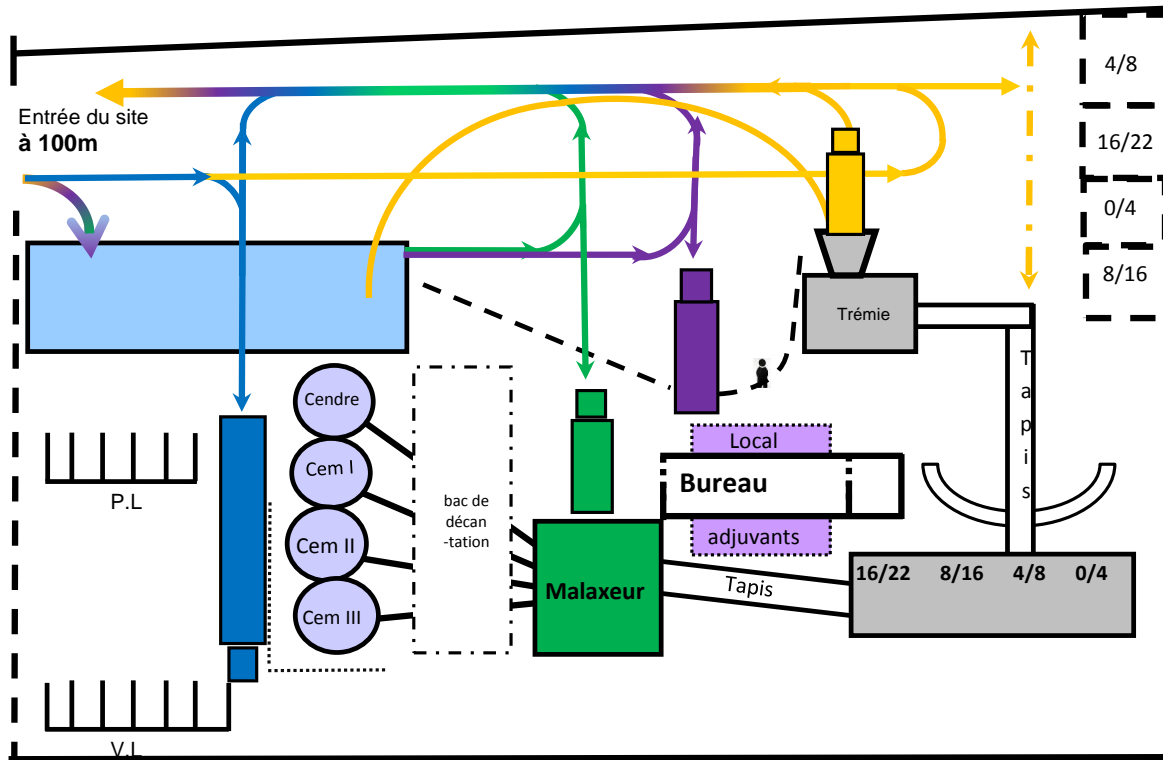







PLAN DE CIRCULATION

CONSIGNES DE SECURITE



-  livraison de granulats
-  chargement de béton
-  livraison Adjuvants
-  livraison de ciments
-  zone d'attente
-  zone de stockage
-  circulation piétonne

Horaires d'ouvertures

Du lundi au vendredi :

De 7h à 12h

&

De 13h à 16h

Téléphone: 03 88 00 61 10

Accès interdit à toute personne non autorisée